

PRODUCT DATA SHEET

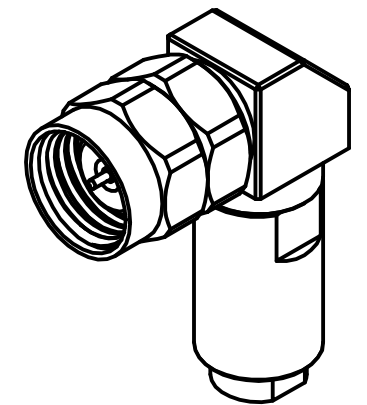
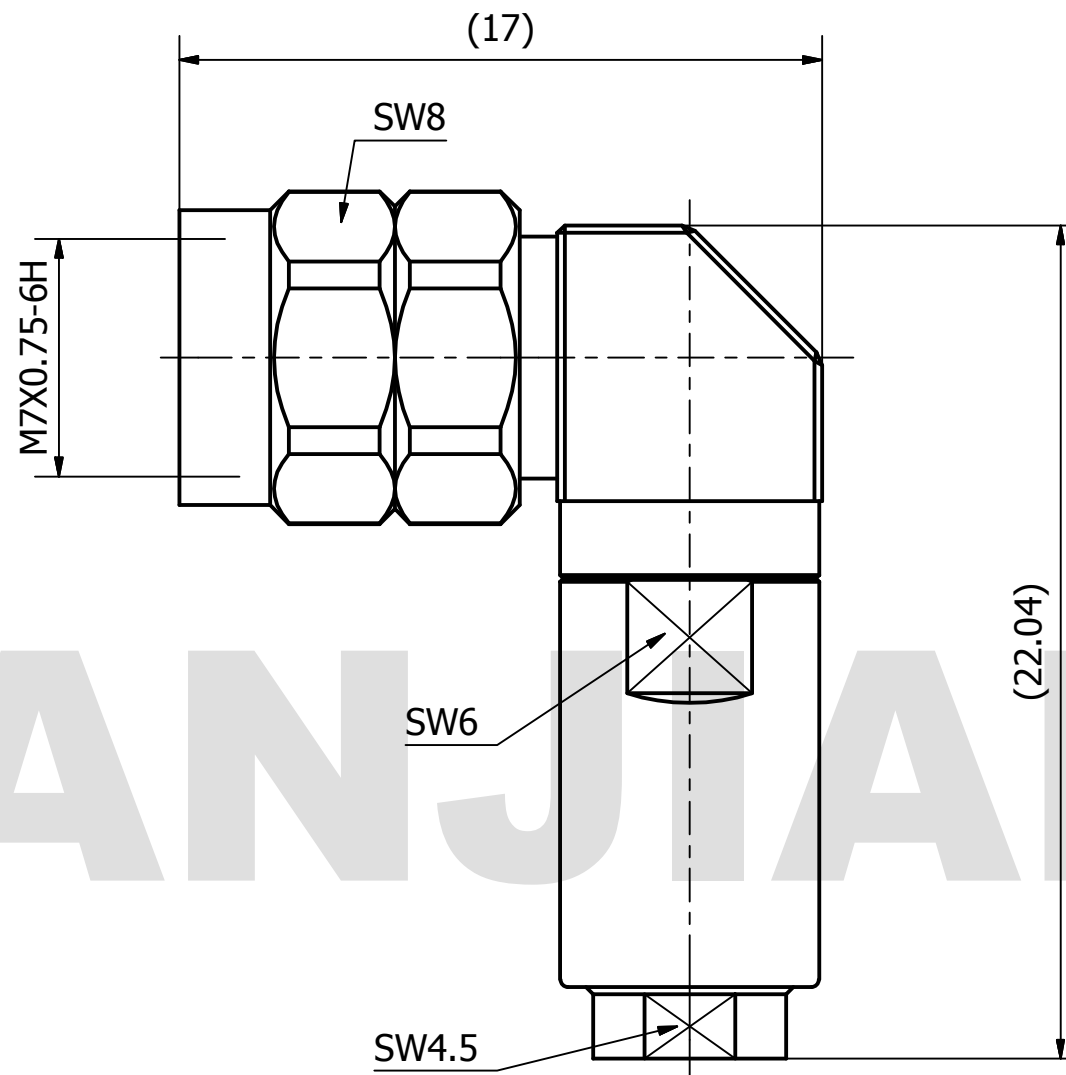

MATERIAL:
 BODY: STAINLESS STEEL PER AMS-5640,
 ALLOY UNS S30300
 CONTACT: BERYLLIUM COPPER PER ASTM B196.
 ALLOY NO. UNS C17300
 INSULATOR: PEI

PERFORMANCE:
 IMPEDANCE: 50 OHMS
 FREQUENCY: DC TO 65 GHz
 VSWR: ≤ 1.50

THIS DOCUMENT CONTAINS CONFIDENTIAL AND PROPRIETARY INFORMATION THAT CANNOT BE REPRODUCED OR DIVULGED, IN WHOLE OR IN PART, WITHOUT WRITTEN AUTHORIZATION FROM "LANJIAN ELECTRONICS"	MATERIAL :		
	UNLESS OTHERWISE SPECIFIED: DIMENSIONS IN MM		
	TOLERANCES :		
	X.X	± 0.20	ANGULAR : $\pm 1^\circ$
	X.XX	± 0.10	FILLETS R/C : ± 0.10
	X.XXX	± 0.01	SURFACE FINISH : Ra 1.6
			DEBURR AND BREAK SHARP EDGES
		NAME	DATE
		SIGNATURE	
		PROJECTION	SIZE
	SCALE		

38 Hengtong Road, Xinqu Dingmao
 Zhenjiang, 212009, Jiangsu, P. R. China

TITLE

1.85-JW3506

R/A pin cable connector

DWG No. GCPZ3.650.U.007 REV.

DO NOT SCALE THE DRAWING PAGE 1 / 1